

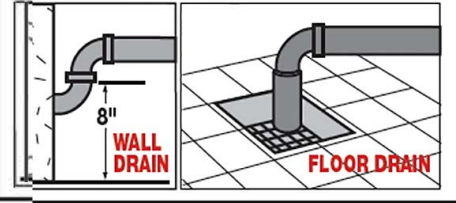

CMA-180-VL 3 Doors/Tall Quick Setup Instructions

STEP 1



Connect a 2" drain pipe (not supplied) from scrap accumulator to floor or wall drain.

STEP 2

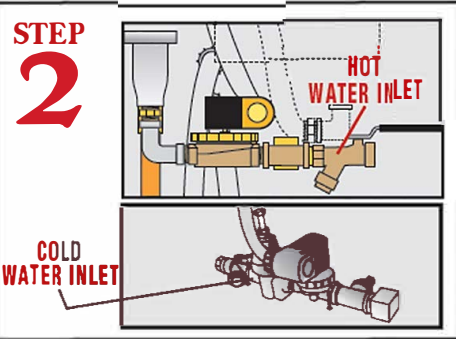

Connect dishmachine to hot water source 120°F - 140°F. Connect cold water inlet (min 41°F and max 65°F). (Review other side for details).

STEP 3

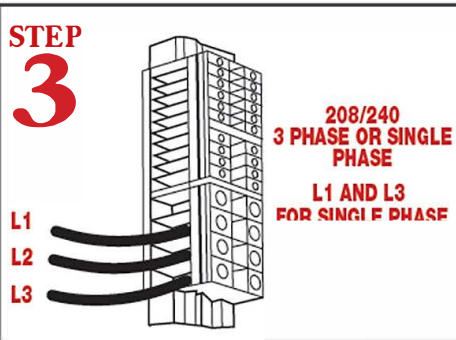

3 Phase: Connect power supply wires, L1, L2 and L3 to the appropriate terminals marked L1, L2 and L3 on the power block. **Important:** If one of the three wires has higher voltage it must be inserted as L-2.

STEP 4

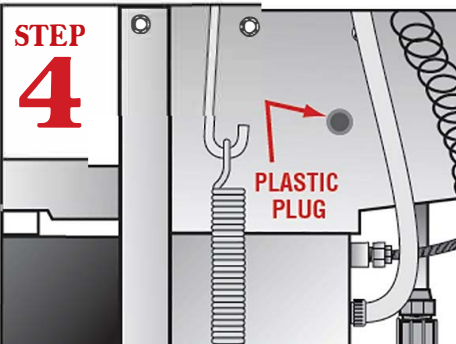

Remove the plastic plug to install the detergent fitting (provided by your dispenser supplier; CMA does not supply).

PN: 10130.17

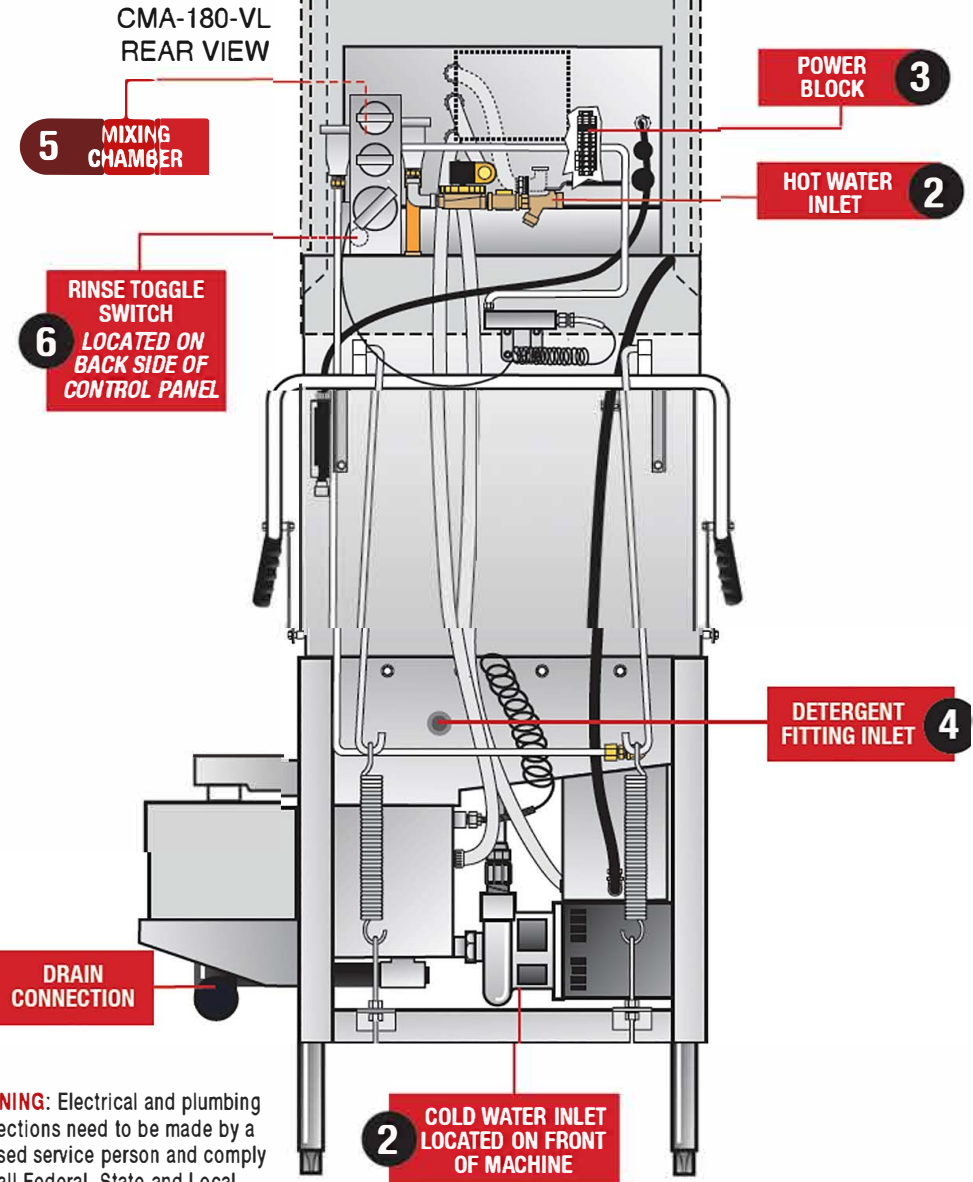

WARNING: Electrical and plumbing connections need to be made by a licensed service person and comply with all Federal, State and Local Health, Electrical, Plumbing and Safety codes.

STEP 5

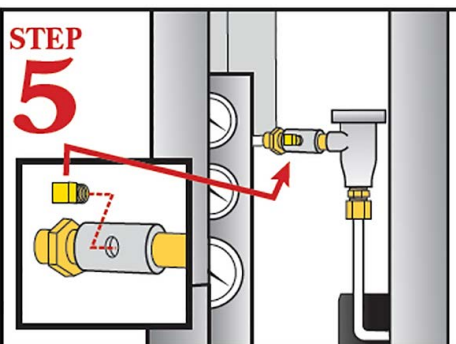

Remove the plug from the mixing chamber and install the rinse injection fitting (rinse injection fitting provided by your dispenser supplier; CMA does not supply).

STEP 6

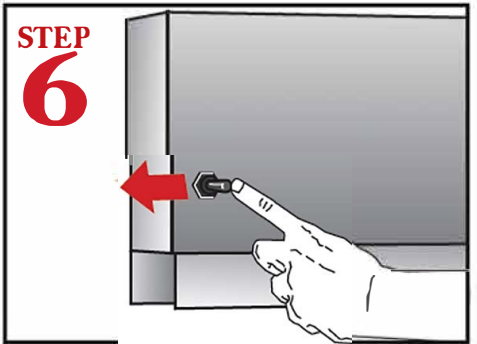

Push "RINSE TOGGLE SWITCH", located on the back of the control box, to fill the booster tank.

07-2021

CMA-180-VL 3 Doors/Tall Quick Setup Instructions

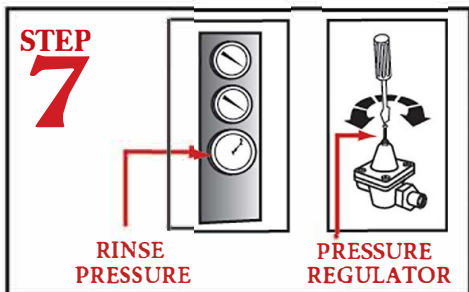

Adjust pressure regulator located next to cold water inlet, to 20 psi (maximum).

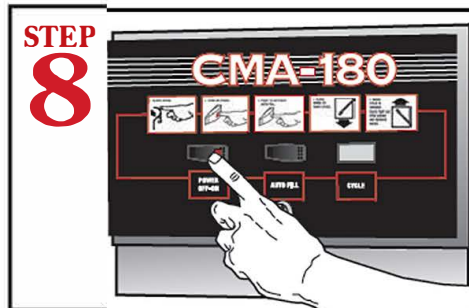

Press "POWER ON/OFF" rocker switch to turn on dishmachine.

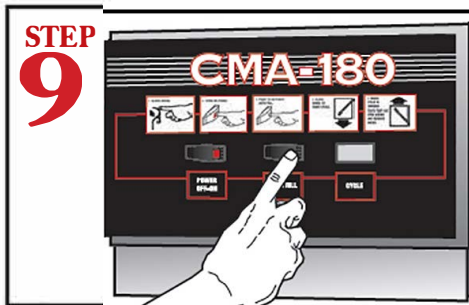

Press "AUTO FILL" immediately after power is turned on. Timer will automatically fill until the water overflows into the scrap trap.

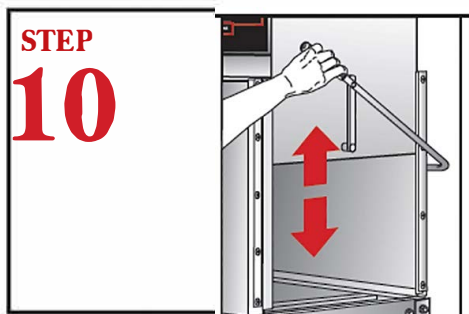

Open dishmachine doors completely. Closing the doors will automatically activate the machine.

NOTE: The wash-down feature for HR Condenser is automatically activated when the machine's "Master Power Switch" is turned "off". Approximately (2) gallons of hot water will spray over the HR Condenser, cleansing and discharging into drain system.

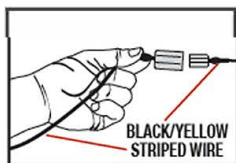

BOOSTER HEATER DAMAGE PREVENTION

CAUTION: TO PREVENT BOOSTER HEATER ELEMENT DAMAGE, CMA HAS DISCONNECTED A WIRE FROM THE "HIGH-LIMIT SWITCH". THE BOOSTER TANK MUST BE FILLED WITH WATER PRIOR TO CONNECTING THE "REMOVED" WIRE, AT THE INITIAL FILLING OF A NEWLY INSTALLED DISHMACHINE. TO FILL THE BOOSTER TANK, LOCATE THE "RINSE TOGGLE SWITCH" ON BACK OF CONTROL BOX. PUSH THE TOGGLE SWITCH TO ACTIVATE THE WATER SOLENOID THAT FILLS THE BOOSTER TANK. THE BOOSTER TANK INDICATES FULL, WHEN YOU CAN OBSERVE WATER SPRAYING FROM THE RINSE ARMS. AT THIS POINT, AND ONLY AT THIS POINT, SHOULD YOU CONNECT THE "DISCONNECTED" WIRE. **FAILING TO FOLLOW THESE IMPORTANT INSTRUCTIONS WILL DESTROY THE HEATING ELEMENT, BECAUSE THE ELEMENT SHOULD ONLY OPERATE WHEN FULLY SUBMERGED IN WATER.**

WARNING: Electrical and plumbing connections need to be made by a licensed service person and comply with all Federal, State and Local Health, Electrical, Plumbing and Safety codes.

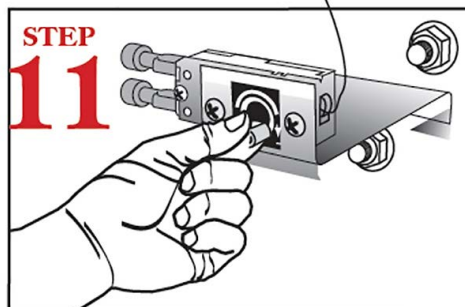
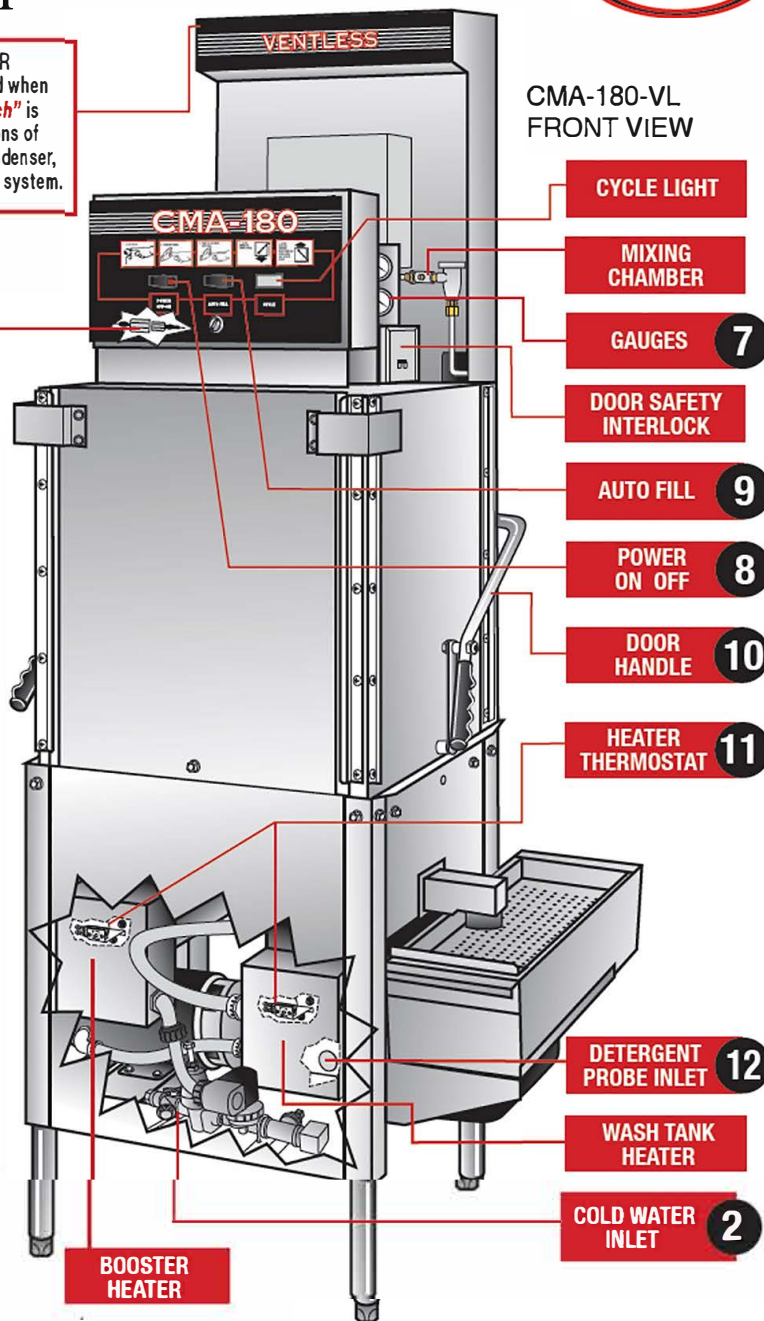

Adjust the temperature by removing the panel in front of the respective heater and turning the adjustment post. Wash temp. 155°F. Rinse temp. 180°F.

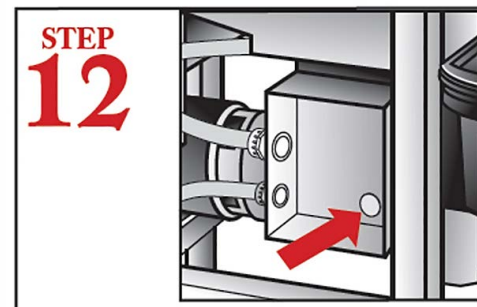

Remove the stainless steel plug to install the detergent probe (provided by your dispenser supplier; CMA does not supply).